

MILLER 400D

DIGITAL RESISTANCE METER

USER'S MANUAL

Revised Sept 22, 2018



11640 US Hwy 1 Sebastian, FL 32958
Tel: 1.772.794.9448 ~ Fax: 1.772.589.9072
E-mail: sales@mcmiller.com ~ Web Site: www.mcmiller.com
Instruments and Software for the Corrosion Engineer

CONTENTS

	Page
Section 1: Description	3
Section 2: How to Take Resistance Readings Manually	4
Section 3: Logging Resistance Readings on a WPAN-Enabled Computer (PDA, Laptop etc.)	5
Section 4: Applications	5
4-Electrode Applications	5
<i>Earth Resistivity Measurement</i>	5
<i>Soil Sample Resistivity Measurement</i>	8
3-Electrode Application	10
2-Electrode Application	13
Section 5: Status Indicators and Error Codes	14
Section 6: Maintenance & Calibration	16
Appendix 1: How to Change Settings (from their default values) Using the Miller 400D Configuration Program	17
Appendix 2: How to use the ProCP Soil Resistivity Survey Program in conjunction with the Miller 400D	22
Appendix 3: Influence of test lead proximity on the accuracy of AC resistance meter readings	34
Appendix 4: Specifications.....	35
Appendix 5: Connecting <i>Configuration Program</i> and <i>Pro CP Soil Resistivity Program</i> via PC-based WPAN adapter	36

FCC Statement:

The Miller 400D Resistance Meter meets current FCC radio frequency exposure guidelines and complies with Part 15 of the FCC Rules.

FCC Equipment Authorization ID: POOWML-C40

SECTION 1: DESCRIPTION

When combined with appropriate electrodes (pins) and test leads, the MILLER-400D can be used to measure earth resistance with the push of a button.

There is no need to adjust dials or select ranges; the MILLER-400D automatically provides a direct resistance reading.

In addition to taking (and recording) readings manually (see Section 2), a WPAN-enabled computer (PDA, laptop etc.) can be programmed to acquire resistance readings directly from the Miller 400D, since the resistance meter has a built-in WPAN interface (see Section 3). In the latter case, the PDA or PC, which is in control of the WPAN link, commands the Miller 400D to take a reading and the resistance value is sent automatically to the PDA or PC.

Depending on the application, 4-Electrode, 3-Electrode or 2-Electrode, the MILLER-400D can be used to determine the following:

- The average earth resistivity to a specific depth (with the application of an appropriate multiplier to convert resistance to resistivity, based on the electrode separation distance) – *4-Electrode Application*
- The resistivity of a soil sample, or of a liquid, via an electrolyte (soil/liquid) box (with the application of an appropriate multiplier to convert resistance to resistivity, depending on the box geometry) – *4-Electrode Application*
- The resistance-to-earth of a buried electrode, such as a ground rod, or an anode, for example – *3-Electrode Application*
- The resistance between two buried electrodes, such as two ground rods, or two anodes – *2-Electrode Application*

The MILLER-400D has a resistance measurement range (with automatic ranging) from 0.01Ω to $10M\Omega$. Over the range, 0.01Ω to $1M\Omega$, the specified meter accuracy is $\pm 1.6\% \pm 1$ LS display digit $\pm 0.01\Omega$ and over the range, $1M\Omega$ to $10M\Omega$, the specified accuracy is $\pm 5.0\% \pm 1$ LS display digit.

Note: The “High Resolution LCD Display Mode” should only be used for resistance values less than 1 ohm.



proximity can also be significant (please see Appendix 3 for details). It should be noted, however, that these accuracy specifications assume a low electrode (pin)/earth contact resistance during the measurement. In this regard, it is recommended that the electrodes (pins) be firmly driven into the earth (pins cannot be loose) and, in dry soils, it is recommended that the soil around the pins be moistened in order that reliable (low resistance) contact be made to the surrounding soil.

The voltage source inside the MILLER-400D that supplies the current used in the resistance measurement is a 12V(rms) crystal-controlled 82.2Hz square wave oscillator and the internal ammeter and voltmeter use very narrow band-pass filters centered at 82.2Hz. What this means is that resistance measurements are unaffected by any stray interference signals (having frequencies other than 82.2Hz) that may be present in the earth during the measurement.

The MILLER-400D runs on a set of replaceable D-size alkaline batteries, so there is no requirement to periodically re-charge the unit or to plug the unit into a power source. Furthermore, due to its extremely low power consumption design, the MILLER-400D can perform 10,000 single resistance readings, for example, on a fresh set of batteries.

SECTION 2: HOW TO TAKE RESISTANCE READINGS MANUALLY

The Read Button is used to initiate a resistance measurement once electrodes and test leads are appropriately connected to the MILLER-400D, as indicated in the Applications Section (Section 4).

A single resistance reading is initiated by depressing the read button once momentarily (for a period of less than 2 seconds).

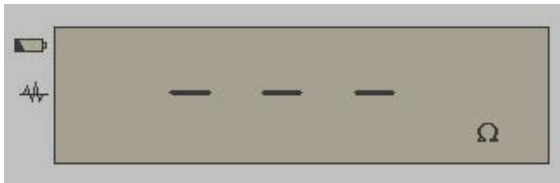

The Ω symbol on the LCD will flash On and Off when a reading is being performed



When the reading has been accomplished, the value will be displayed and the appropriate units highlighted (M Ω , K Ω or Ω)



The LCD will be as indicated in cases where the measured resistance is higher than 10M Ω

The resistance reading will be displayed for a period of time (1 minute by default) after which the LCD will go blank until the read button is momentarily depressed again to take another reading. Another reading can also be initiated while the previous reading value is being displayed.

By depressing the read button twice, rather than once, continuous resistance readings will be initiated. In the continuous mode, a resistance reading will be taken and displayed every 3 seconds. The process is terminated by depressing the read button a third time. Also, the process will self-terminate after 10 readings by default. Although this mode consumes more battery power, it may be desirable to observe the resistance reading as a function of time for some period of time in order to check for consistency.

The read button can also be used to initiate a self-calibration process (please see the Maintenance & Calibration Section (Section 6)).

SECTION 3: LOGGING RESISTANCE READINGS ON A WPAN- ENABLED COMPUTER (PDA, LAPTOP ETC.)

A WPAN-enabled computer can be programmed to acquire resistance readings directly from the MILLER 400D and, with electrodes and test leads appropriately connected to the meter, as indicated in the Application Section (Section 4), resistance readings can be logged via a software application.

For instance, the MILLER 400D is supplied with an “over-the-pipe” soil resistivity survey program, known as “ProCP Soil Resistivity”, which is based on the 4-pin Wenner Methodology. Please see Appendix 2 for information on this software application.

SECTION 4: APPLICATIONS

4-ELECTRODE APPLICATIONS

1. Earth Resistivity Measurement

This application uses 4 electrodes (pins). The electrodes are driven down into the earth the same



11640 US Hwy 1 Sebastian, FL 32958
Tel: 1.772.794.9448 ~ Fax: 1.772.589.9072
E-mail: sales@mcmiller.com ~ Web Site: www.mcmiller.com
Instruments and Software for the Corrosion Engineer

distance and are evenly spaced in a straight line. A schematic of this arrangement is illustrated in Figure 1 below.

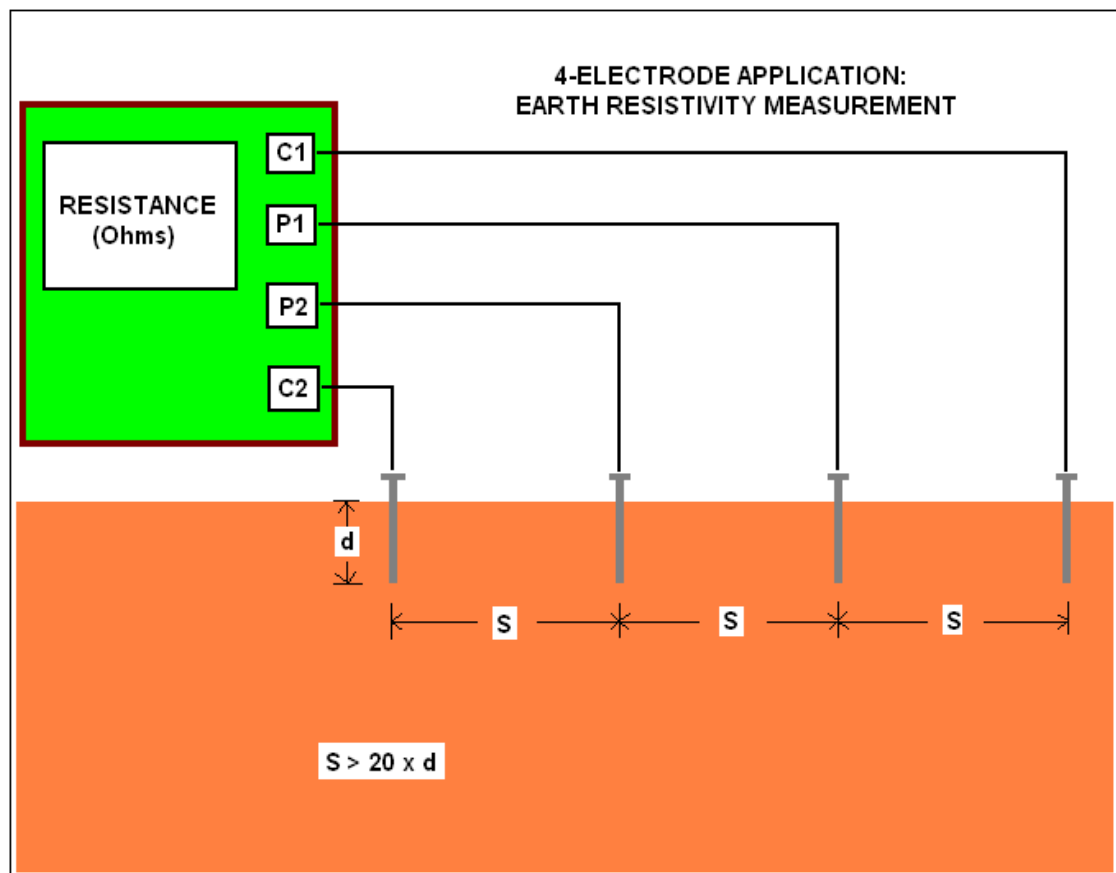

Figure 1

The MILLER-400D can be used in conjunction with M. C. Miller's 4-lead (color-coded) test reel (catalog # 44700) and four heavy-duty (stainless steel) electrodes (soil pins) – catalog # 44720. The test leads are connected to the MILLER-400D as shown in Figure 1. With this arrangement, the MILLER-400D displays the earth's average resistance to a depth equal to the electrode spacing (S), based on the magnitude of the current flowing between terminals C1 and C2 and the voltage dropped between terminals P1 and P2. **Note:** For load resistances $>1\text{M}\Omega$, in addition to internal meter errors, errors associated with test lead proximity can also be significant (please see Appendix 3 for details).

Dr. Frank Wenner of the U.S. Bureau of Standards developed the theory behind this test in 1915 [1]. He showed that, if the electrode (pin) depth (d) is kept small relative to the separation between the electrodes (S), the earth's average resistivity to a depth equal to the electrode spacing (S) can be obtained by applying the following formula:

$$\rho = 2 \pi S R$$



where R is the resistance value in ohms as displayed on the MILLER-400D, ρ is the resistivity in ohm.cm, π is the constant 3.1416, and S is the electrode separation in cm.

Typically, the electrode (pin) spacing is not measured in centimeters but, rather, in feet (in the U.S.) or in meters (in most other countries).

U.S. Example (electrode spacing measured in feet):

Since there are 30.48 centimeters in 1 foot, the above formula can be written as:

$$\rho (\Omega.\text{cm}) = 2\pi \times 30.48 \times (\text{electrode spacing in feet}) \times R (\text{ohms})$$

$$\text{or, } \rho (\Omega.\text{cm}) = 191.5 \times (\text{electrode spacing in feet}) \times R (\text{ohms})$$

So, for example, if the MILLER-400D displays a resistance value of 15 ohms for an electrode (pin) spacing of 20 feet, the earth's average resistivity value to a depth of 20 feet would be:

$$\rho = 191.5 \times 20 \times 15 = 57,450 \text{ ohm.cm}$$

If the resistivity value is required to be expressed in ohm.m, rather than ohm.cm, the ohm.cm value is divided by 100. In the above example, the resistivity would be 574.5 ohm.m

Metric Example (electrode spacing measured in meters):

Since there are 100 centimeters in 1 meter, the above formula can be written as:

$$\rho (\Omega.\text{cm}) = 2\pi \times 100 \times (\text{electrode spacing in meters}) \times R (\text{ohms})$$

$$\text{or, } \rho (\Omega.\text{cm}) = 628.32 \times (\text{electrode spacing in meters}) \times R (\text{ohms})$$

So, for example, if the MILLER-400D displays a resistance value of 15 ohms for an electrode (pin) spacing of 7 meters, the earth's average resistivity value to a depth of 7 meters would be:

$$\rho = 628.32 \times 7 \times 15 = 65,973.6 \text{ ohm.cm}$$

If the resistivity value is required to be expressed in ohm.m, rather than ohm.cm, the ohm.cm value is divided by 100. In the above example, the resistivity would be 659.73 ohm.m

Note: The above formula is accurate only if the electrode depth (d) is small relative to the electrode



spacing (S). An “S” value equal to, or greater than, 20 times the “d” value is recommended. This means that if d is 1 foot, for example, then S has to be at least 20 feet (or, if d is 0.3 meter, then S has to be at least 6 meters)

The Wenner Method is the basis of an ASTM Standard Test Method (ASTM G57-06).

2. Soil Sample (or Liquid) Resistivity Measurement

This application also uses 4 electrodes, however, in this case, the electrodes are an integral part of an electrolyte box, which is more commonly referred to as a soil box. For this application, the MILLER-400D can be used in conjunction with one of M. C. Miller’s soil boxes (catalog # 37008 or catalog # 37006) and 4 test leads (catalog # 37009).

A schematic of the test arrangement is illustrated in Figure 2 below.



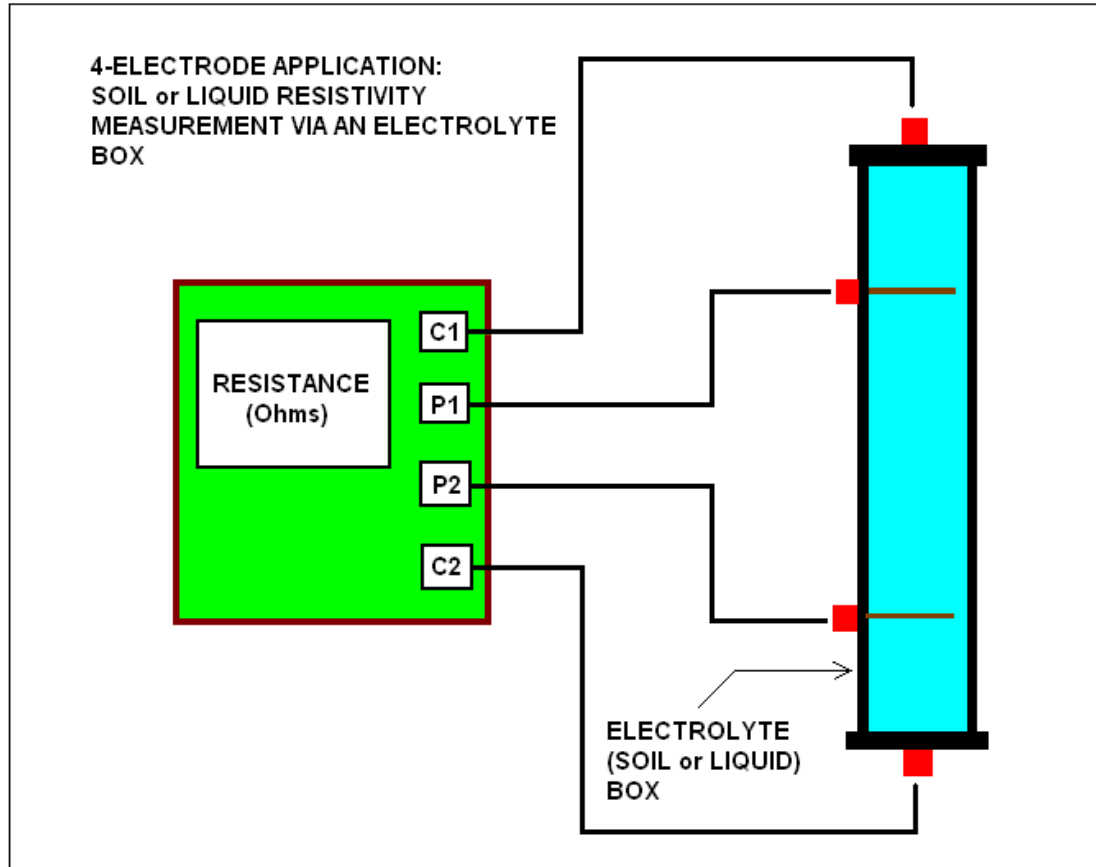

Figure 2

For this application, the test leads are connected to the MILLER-400D as shown in Figure 2.

With this arrangement, the MILLER-400D displays the resistance of the soil sample, or of the liquid that fills the electrolyte box, based on the magnitude of the current flowing between terminals C1 and C2 and the voltage dropped between terminals P1 and P2.

In general, for a particular volume of soil sample (or liquid), as defined by the geometric constraints of the electrolyte box, the sample's resistivity can be calculated from the resistance value displayed by the MILLER-400D using the following formula:

$$\rho = R A/L$$

Where 'ρ' is the resistivity in 'ohm.cm', 'R' is the resistance in ohms, 'A' is the cross-sectional area of the current electrodes in 'cm squared', and 'L' is the separation between the potential electrodes in 'cm'.

Consequently, the ratio A/L represents a multiplication factor that needs to be applied to the resistance reading in order to obtain the sample's resistivity value.

Conveniently, for both M. C. Miller soil boxes, the A/L ratio is exactly 1cm.

Consequently, when M. C. Miller soil boxes are used, the reading in ohms (or $k\Omega$) displayed on the MILLER-400D becomes the resistivity value in 'ohm.cm' (or $k\Omega.cm$).

If the resistivity value is required to be expressed in ohm.m, rather than ohm.cm, the ohm.cm value is divided by 100. For example a resistivity value of 2500 ohm.cm would be equivalent to 25 ohm.m

3-ELECTRODE APPLICATION (Fall of Potential)

The 3-Electrode Application can be used to measure the resistance-to-earth of a buried electrode, such as a buried ground rod or a buried anode.

In this case, two of the electrodes are pins driven into the earth and the third electrode is the test electrode itself, for example, a ground rod or an anode.

A resistance-to-earth measurement will actually comprise 3 components; the resistance of the electrode itself (the resistance of the ground rod or anode material, for example) including test leads, the electrode-earth contact resistance and the resistance of the surrounding earth. Typically, the resistance of the surrounding earth is the largest component of the resistance-to-earth measurement.

The three electrodes are positioned in a straight line (ideally) as indicated in Figure 3 below.



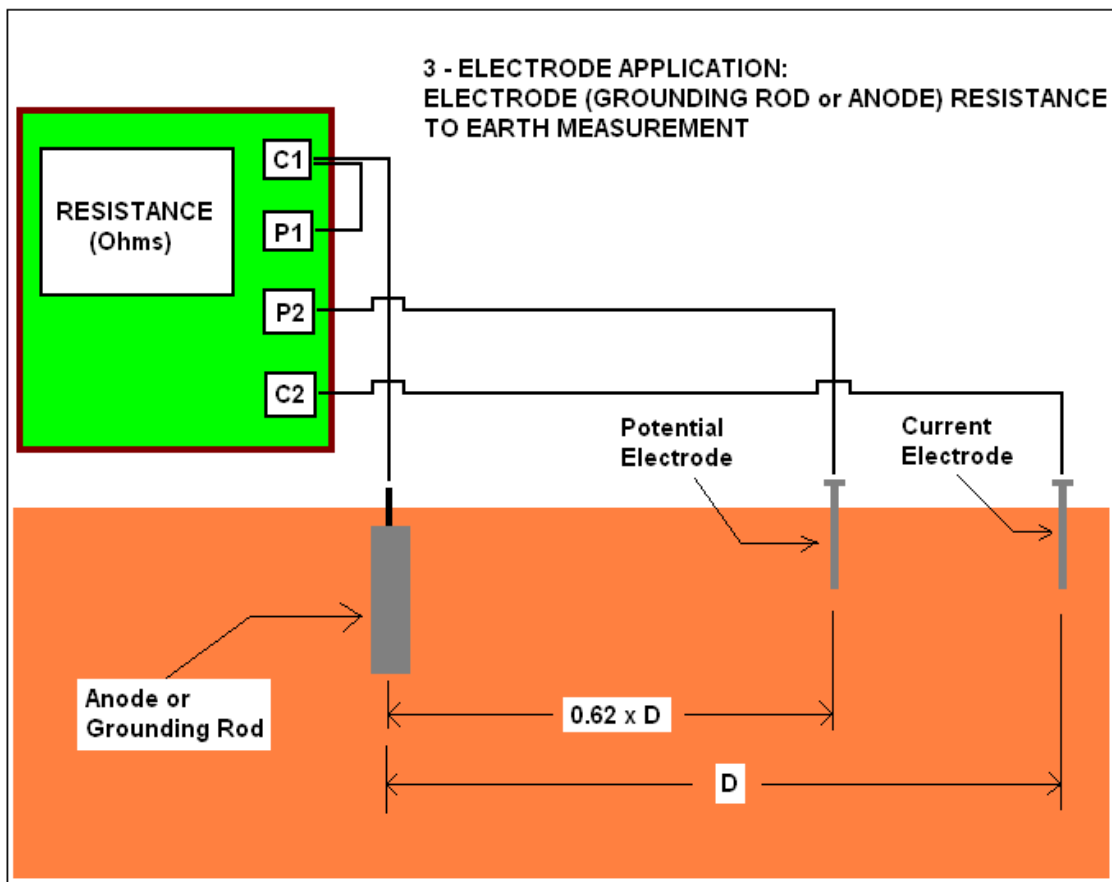

Figure 3

As indicated in Figure 3, a jumper wire is connected between the C1 and P1 terminals on the MILLER-400D and test leads connect the “Potential Electrode” and the “Current Electrode” to terminals P2 and C2, respectively. Finally, a test lead connects the electrode under test (a ground rod or an anode, for example) to the C1 terminal.

With this configuration, the MILLER-400D passes a current between the test electrode and the “Current Electrode” and generates a resistance reading based on the voltage dropped between the electrode under test and the “Potential Electrode”.

The magnitude of the resistance reading will be a function of the separation (distance) between the electrode under test and the “Potential Electrode”, with respect to a fixed position for the “Current Electrode”.

A characteristic “resistance versus distance” plot is illustrated in Figure 4 below.

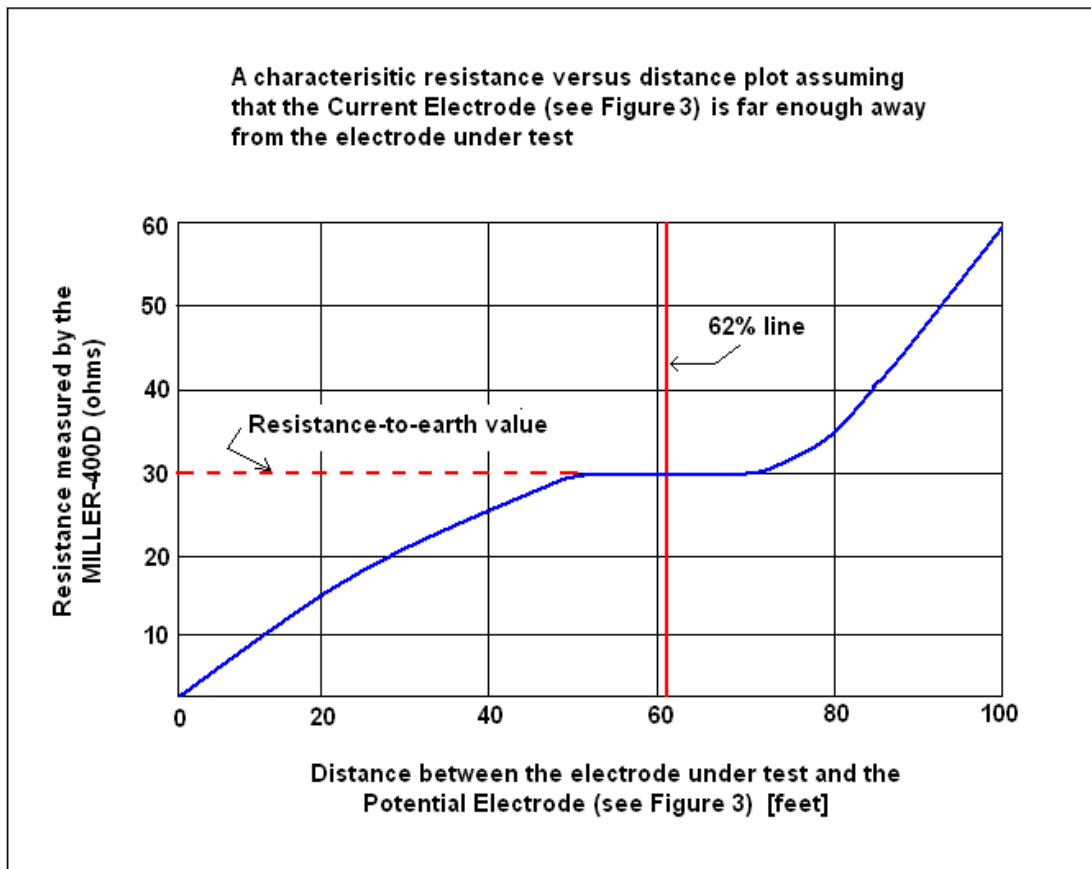

Figure 4

This type of plot assumes that the “Current Electrode” (see Figure 3) is positioned far enough away from the electrode under test so that a “plateau” region is obtained in the plot. A 100 foot separation is typically recommended. However, it is suggested that a resistance versus distance curve be generated for any given situation in order to verify the existence of a plateau-type region which will allow an accurate determination of the electrode-to-earth resistance.

Assuming that a plateau-type region is obtained, the resistance-to-earth value for the electrode under test will be the resistance value on the plot corresponding to the plateau region as illustrated in Figure 4.

A general rule-of-thumb, which assumes that the “Current Electrode” is positioned sufficiently far away from the electrode under test, is that if the “Potential Electrode” is positioned at a distance from the test electrode of $0.62 \times D$, where D is the distance between the electrode under test and the “Current Electrode”, the resistance reading observed will correspond to the resistance-to-earth value for the electrode under test.

This particular configuration is illustrated in Figure 3. For example, if the distance between the electrode under test and the “Current Electrode” is 100 feet, the “Potential Electrode” should be positioned 62 feet from the electrode under test. However, again, it is suggested that resistance versus distance plots be generated in each instance.

2-ELECTRODE APPLICATION

The 2-Electrode Application can be used to measure the resistance between two buried electrodes, such as two ground rods, or two anodes, for example.

In this case, the two electrodes are the two buried components. Figure 5 below illustrates the measurement configuration.

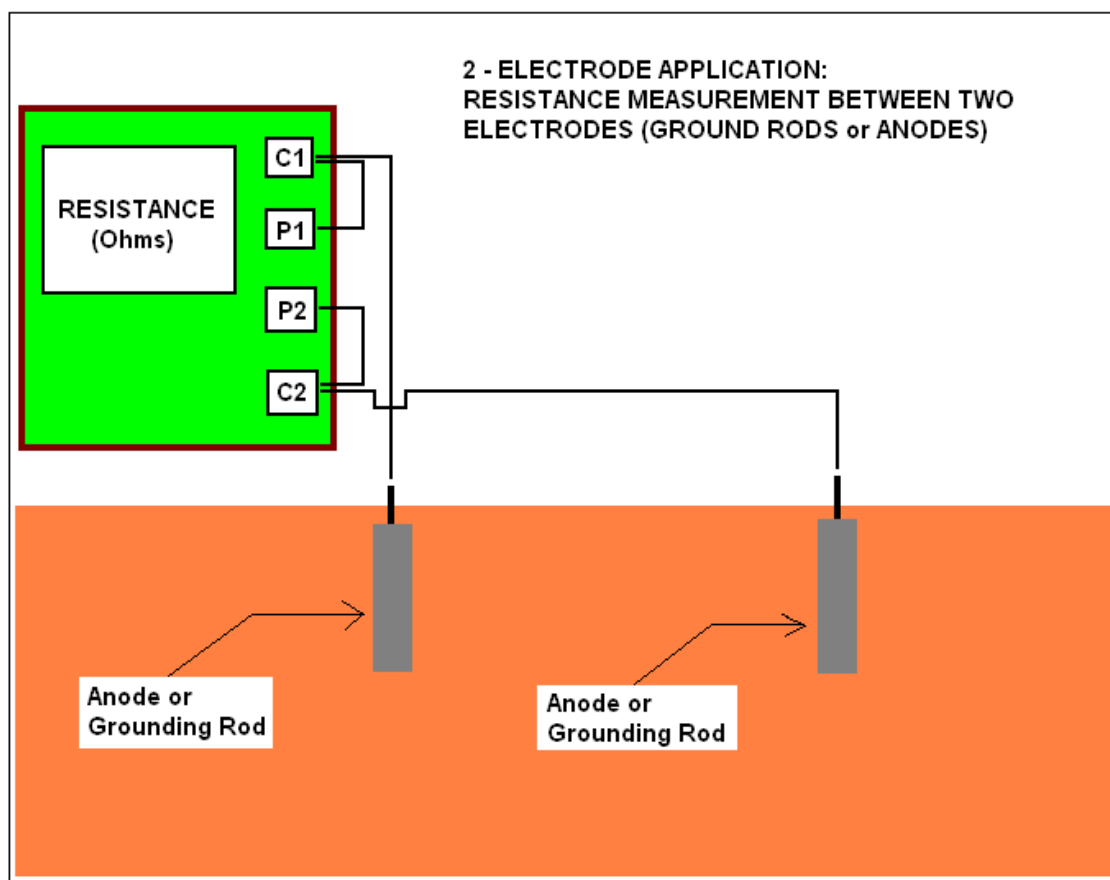

Figure 5

As indicated in Figure 5, in this configuration, jumper wires are connected between terminals C1 and P1 and between terminals C2 and P2. In addition, test leads connect one of the electrodes to terminal C1 and the other electrode to terminal C2.

Another configuration option, which is recommended for use when measuring small resistances, is to connect the potential terminals (P1 and P2) directly to the electrodes with separate test leads, thus eliminating the jumper wires. Such a configuration eliminates any voltage drop in the test leads due to current flow in the leads which would appear in series with the voltage drop occurring between the electrodes in the case of the configuration shown in Figure 5.

The reading displayed on the MILLER-400D will be a direct measurement of resistance comprising 2 components; the resistance-to-earth contribution of each electrode (which itself comprises 3 components (see the “3-Electrode Application” section above) and the earth’s resistance between the two electrodes.

SECTION 5: STATUS INDICATORS & ERROR CODES

Status Indicators:

There are 3 status indicators on the MILLER-400D. A light bar in the LCD positioned opposite each of 3 icons will indicate particular scenarios. The 3 icons are shown below and are located to the left-hand-side of the LCD. From top to bottom, the icons represent the battery, the noise status and the WPAN radio.



Battery Indicator:

The battery indicator provides a warning that it’s time to replace the batteries in the MILLER-400D (see the Maintenance & Calibration Section (Section 6) for details).

The indicator bar (opposite the battery icon) will be ON when there is only 20% of the charge remaining and the indicator will flash ON and OFF when there is 10% or less charge remaining. When the battery charge is at a critically-low level, the unit will not perform a resistance measurement. Consequently, it is recommended that batteries be replaced when the battery indicator first lights up.

Noise Indicator:

Generally-speaking, readings taken by the MILLER-400D are not affected by external noise sources, since the unit employs narrow band-pass filters centered at 82.2Hz, which makes interference from 50Hz, 60Hz, 100Hz or 120Hz signals, for example, highly unlikely.

However, to guarantee accurate resistance measurements, the MILLER-400D examines all signals appearing at its input terminals and the noise indicator alerts the user to specific issues as follows:
Flashing On and Off presentation: Indicates that the unit has detected a large voltage (>35V) at its input terminals in front of the filter. Should such large external sources appear across the input terminals, the unit will disconnect itself. Any displayed resistance values on the LCD should be ignored when the noise indicator is flashing On and Off. **Note:** Once the over-voltage is removed, the unit should be re-started by (momentarily) depressing the Read button.

Steady ON presentation: Indicates that the unit has detected external interference signals after the filter when its internal voltage source has been switched off. This situation would imply that the resistance measurement is compromised and the reading should be ignored.

Also, the *Steady ON* presentation of the noise indicator will be observed during the Continuous Reading Mode (in which readings are presented at 3 second intervals continuously) should either of the following two scenarios occur: A new resistance value is larger than twice the previous value or a new resistance value is smaller than half of the previous value. Such scenarios could occur if the test leads are disturbed during the continuous reading process, for example. In this case, readings should also be ignored.

WPAN Indicator: (Only on models prior to SN:1565)

If a WPAN-enabled PDA or PC is being used to log resistance data generated by the MILLER-400D, the WPAN Indicator will be ON when a link has been established between the MILLER-400D and the PDA or PC.



Error Codes:

The following are the error codes that may be displayed on the LCD:



Er1 Detected an internal power supply failure

Er2 Detected an internal communications failure when sending

Er3 Detected an internal communications failure when receiving

Er4 Detected a calibration error

Should any of above codes be displayed, please contact the M. C. Miller Company.

SECTION 6: MAINTENANCE & CALIBRATION

Other than changing the batteries, the MILLER-400D requires no maintenance.

The procedure to change the 5 D-size alkaline batteries in the unit is as follows:

Unscrew both battery holder covers (rotate covers clockwise to unscrew) and remove the old batteries. Install five 1.5Volt D-size alkaline batteries, positive terminals facing out, (3 batteries in one holder and 2 batteries in the other) and replace the battery holder covers (rotate covers counter-clockwise).

With respect to calibration, the MILLER-400D is self-calibrating and the user can select to have the unit calibrate itself before every measurement or can select to have the unit self-calibrate at his/her request (default setting). If the latter selection is made, the self-calibration process is initiated by depressing the "Read" button for a period of 10 seconds.

When performing an auto (self) calibration, the LCD will be as shown below:



The "Ω" symbol (located at the bottom right-hand corner of the LCD) will flash ON and OFF during the calibration process and will stop flashing when the re-calibration sequence is complete (approximately a 10 second process). The unit self-calibrates after the batteries have been replaced.



11640 US Hwy 1 Sebastian, FL 32958
Tel: 1.772.794.9448 ~ Fax: 1.772.589.9072
E-mail: sales@mcmiller.com ~ Web Site: www.mcmiller.com
Instruments and Software for the Corrosion Engineer

Reference:

[1] F. Wenner, "A Method of Measuring Earth Resistivity", Bulletin of Bureau of Standards, Report # 258, Vol. 12, No. 3, Oct. 11, 1915

Appendix 1: How to Change Settings Using the Miller 400D Configuration Program

The Miller 400D Resistance Meter is supplied with factory settings (default settings) for a group of five parameters. The five parameters are defined in the table below and their default values (or settings) are indicated.

Parameter	Explanation of Parameter	Default Value /Setting
Number of Continuous Readings Range of values, 3-255 readings	In the Continuous Reading Mode (see Section 2), a new reading is displayed every 3 seconds. When the selected number of readings have been taken, the process will self-terminate	10 readings
Auto Shut Down Time Range of Values, 1-10 minutes	In the Single Reading Mode (see section 2), the LCD shuts down (reading value is no longer displayed) after a set period of time in order to conserve power	1 minute
WPAN Radio Setting Options: Radio Always ON or Radio ON Upon Demand	In the default setting (WPAN radio ON upon demand), which is the power-saving mode, the WPAN radio is turned ON and OFF by the software applications, either the Configuration Program or the <i>ProCP Soil Resistivity</i> Program	WPAN Radio ON Upon Demand
Self-Calibration Setting Options: Calibrate on Demand or Calibrate before each Reading Sequence	In the power saving default setting (Calibrate on Demand), the self-calibration process is initiated by use of the Read button (see Section 6). With the other option, a calibration process (a 10 second event) is initiated each time a reading is requested (Single Reading Mode) or at the start of each Continuous Reading Mode cycle	Self-Calibrate on Demand
Resolution Setting for $R < 1\Omega$ Options: LCD shows 0.001Ω resolution or LCD shows 0.01Ω resolution	In the default setting, the LCD will display the resistance value in the format 0.XX Ω . With the other setting, the display will be in the format 0.XXX Ω . (This option should be used only for resistance values less than 1 ohm). Note: Data received by a PC will always have highest resolution regardless of display format	LCD shows 0.01 Ω Resolution



After installing the Configuration Program (from the CD that was supplied with the Miller 400D) onto your PC or PDA and opening the application, the window shown below will be displayed:

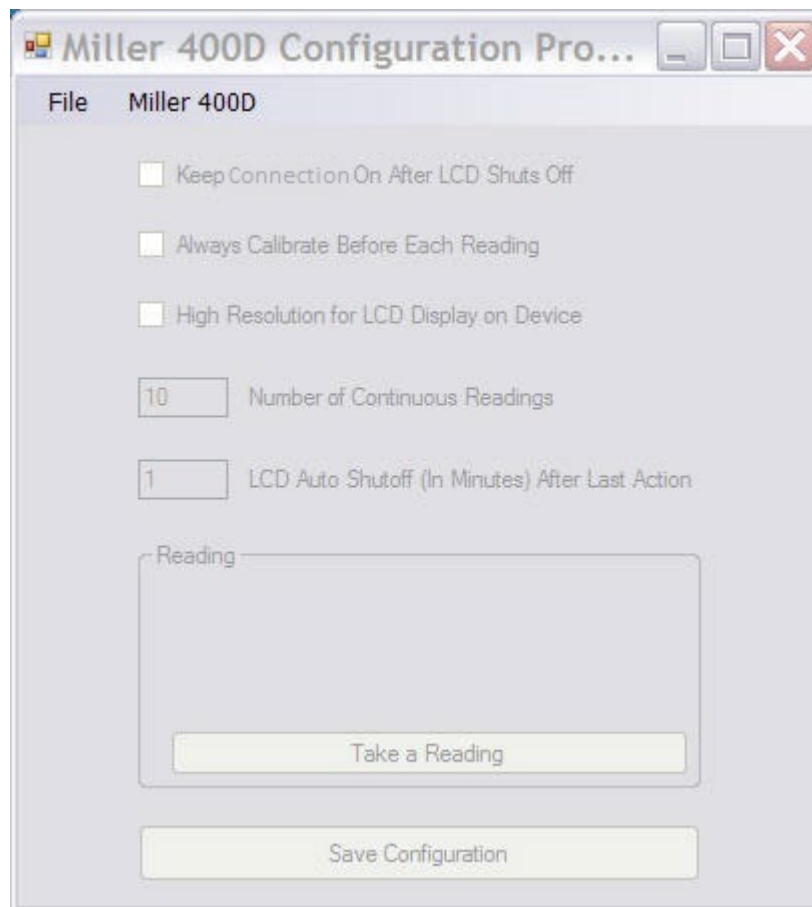

A WPAN connection is initiated by the Configuration Program via the following procedure:

With the PDA or PC within range (within 30 feet) of the Miller 400D, left-mouse click or tap on the “**Miller 400D**” menu and click or tap on the “**Connect**” option, as indicated below. You may refer to “**Appendix 5**” for more details regarding the connection of the “**...400D**” to a PC equipped with a WPAN adapter.

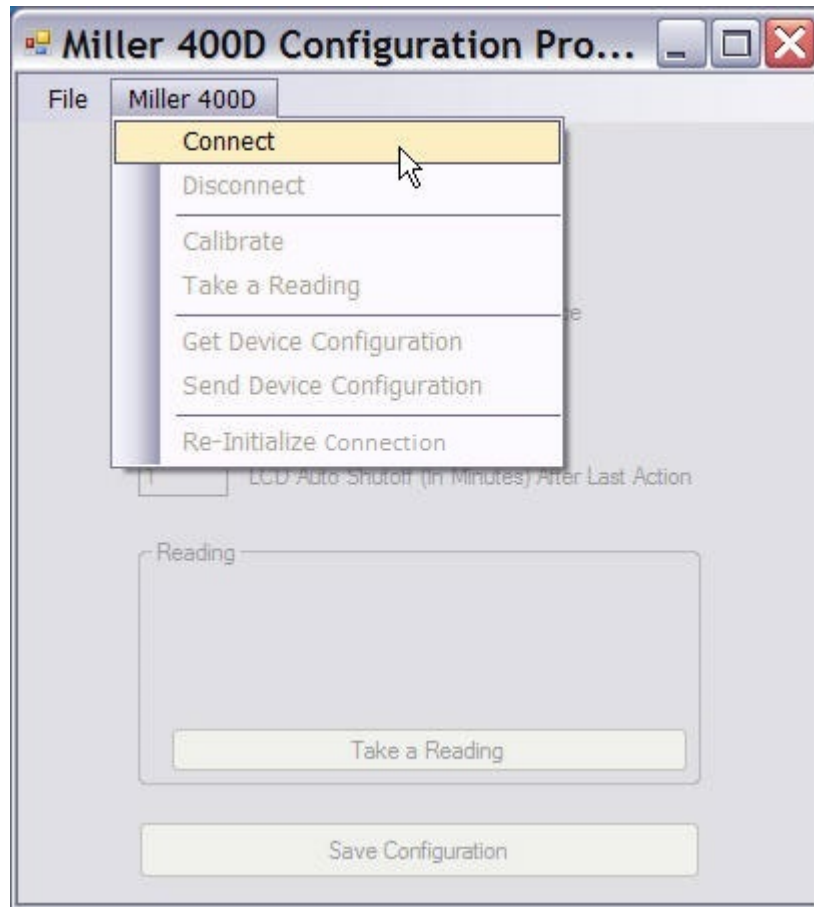

The following message will be displayed: “Make sure that the Miller 400D is turned ON”. At this point, depress the “Read” button on the Miller 400D, which turns the unit ON and immediately click or tap on the “Yes” button in response to the message.

Note: A few seconds are required to establish a connection. Also, the above process may have to be repeated more than once for a WPAN connection to be established.

When a connection is established, the window shown below will be displayed:

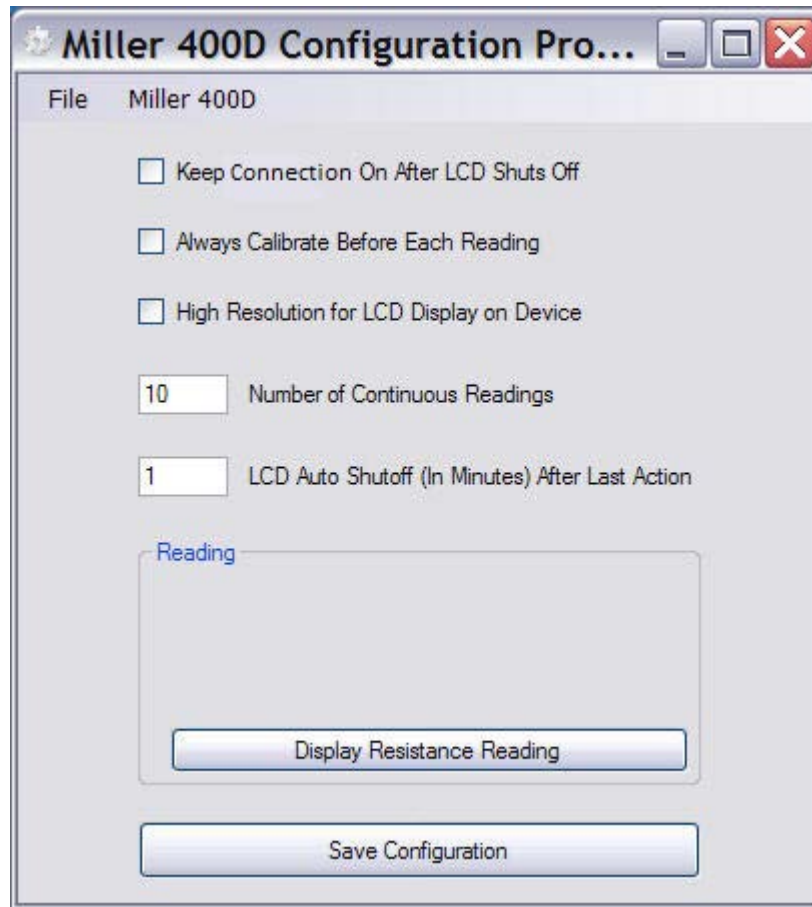

Changes to the (power-saving) default settings can be made, if necessary, via the above window.

Also, a reading can be initiated and the meter reading can be displayed on the above window either by clicking or tapping on the “Display Resistance Reading” button, or, by depressing the “Read” button on the Miller 400D. The reading acquisition time is 3-5 seconds. See the window below for an example.

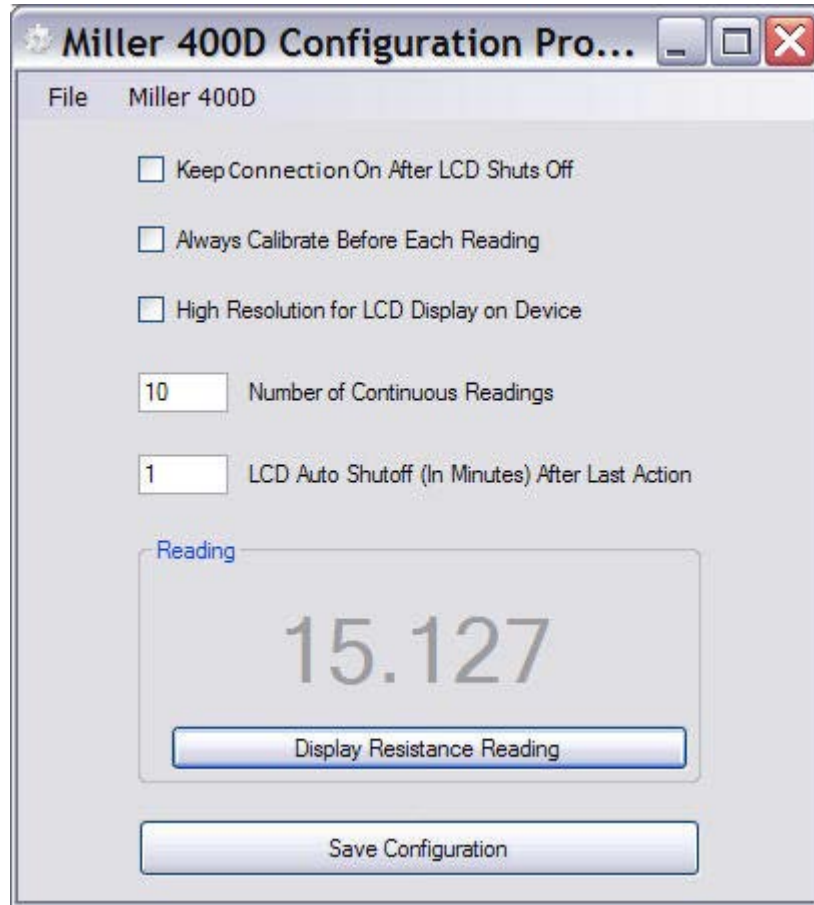

Finally, click or tap on the “Save Configuration” button, if any changes were made, and then select the “**Disconnect**” option from the “Miller 400D” menu, while in range of the Miller 400D.

Note: Disconnecting the WPAN connection will allow the WPAN radio in the Miller 400D to switch OFF (power-saving mode) after the LCD shuts down.

WARNING: If the software disconnection process is not carried out (within range of the Miller 400D), the WPAN radio will remain ON, even when the LCD automatically shuts down.

Appendix 2: How to Use the ProCP Soil Resistivity Survey Program in Conjunction with the Miller 400D Resistance Meter

The MILLER 400D is supplied with an “over-the-pipe” soil resistivity software program, known as “ProCP Soil Resistivity”, which is based on the 4-pin Wenner Methodology (see Section 4 – Earth Resistivity Measurement). The program needs to be run on a WPAN-enabled PDA or PC. Also, if a GPS receiver is integrated with the PDA or PC, GPS location data are logged automatically at soil resistivity measurement sites.

After installing the program from the CD supplied with the Miller 400D, either the PC version or the PDA version, and opening the program, the window shown below will be displayed:



As indicated on the header of the above window, the Miller 400D is currently **not connected**, via WPAN, to the PDA or PC. You may refer to “**Appendix 5**” for more details regarding the connection of the “**...400D**” to a PC equipped with a WPAN adapter.

The WPAN connection is initiated (and subsequently maintained) by the software program (ProCP Soil Resistivity) using the following procedure:

With the PDA or PC within range (within 30 feet) of the Miller 400D, left-mouse click or tap on the “**Miller 400D**” menu and click or tap on the “**Connect**” option, as indicated below.

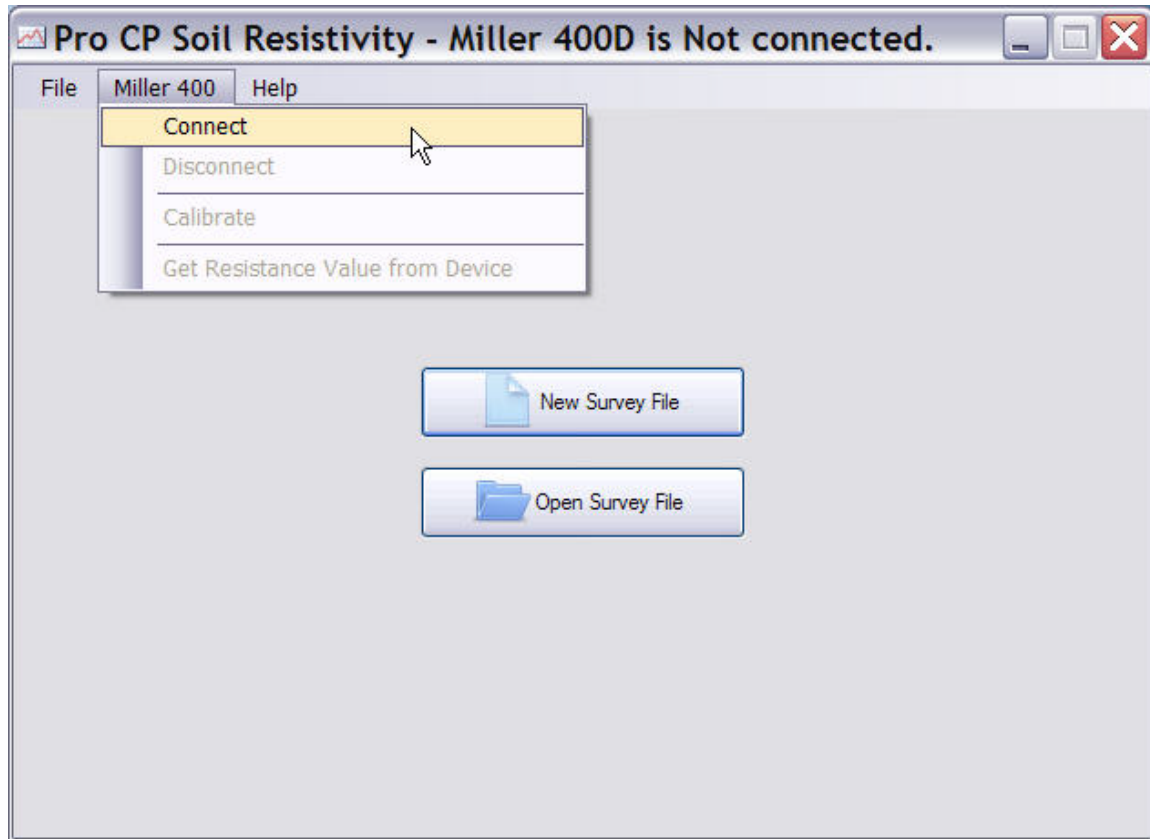

The following message will be displayed: “Make sure that the Miller 400D is turned ON”. At this point, depress the “Read” button on the Miller 400D, which turns the unit ON and immediately click or tap on the “Yes” button in response to the message.

Note: The above process may have to be repeated more than once for a WPAN connection to be established.

Approximately 16 seconds are required to establish a connection and to have the software be “in control” of the WPAN radio in the Miller 400D unit.

The window shown below will be displayed when a WPAN connection has been successfully established. Please note the header indication (Miller 400D is connected) on the window.

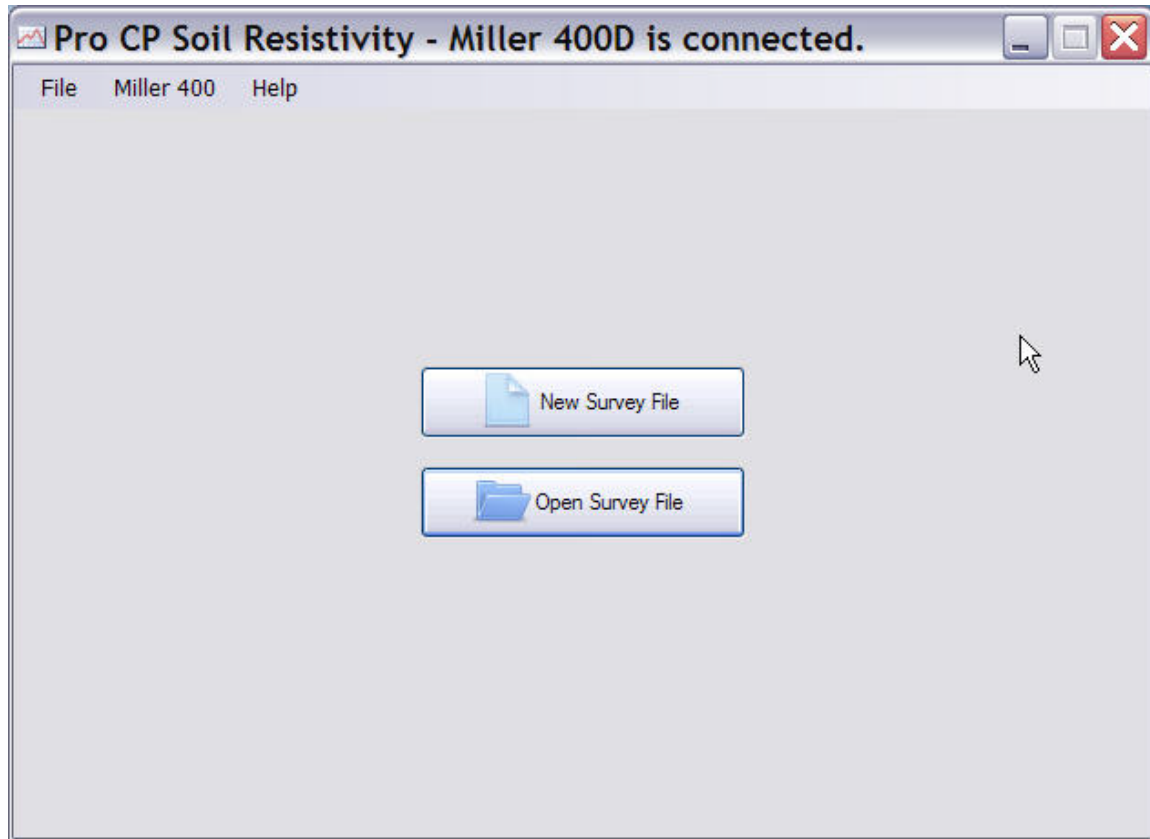

Creating a new survey file or re-opening a pre-existing survey file

Creating a new survey file:

A new soil resistivity survey file is established by clicking or tapping on the “New Survey File” button on the above window and identifying a previously-created folder (perhaps located in your “My Documents” folder) as the target folder for the survey file.

A target folder for the survey file is selected by clicking on the “Browse for Folder” button indicated by the arrow on the window shown below. In the example window (see below), a previously-created folder named “SR Surveys” is highlighted to be the parent folder for soil resistivity survey files.

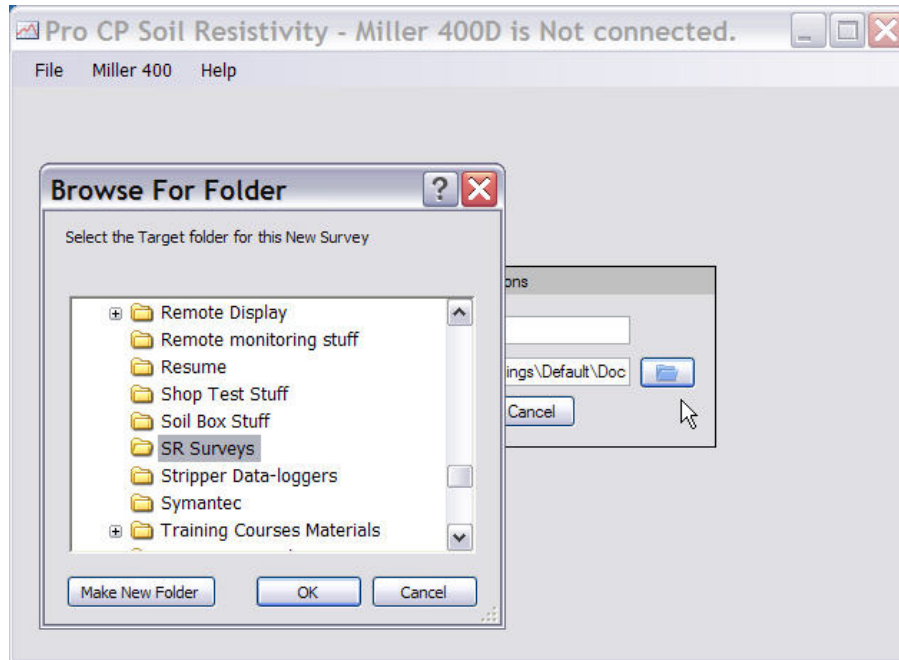

Following target folder identification, enter a name for the survey file, as indicated in the window shown below, and click or tap on the “Accept” button. In the example shown, the survey file name is “MCM survey”.

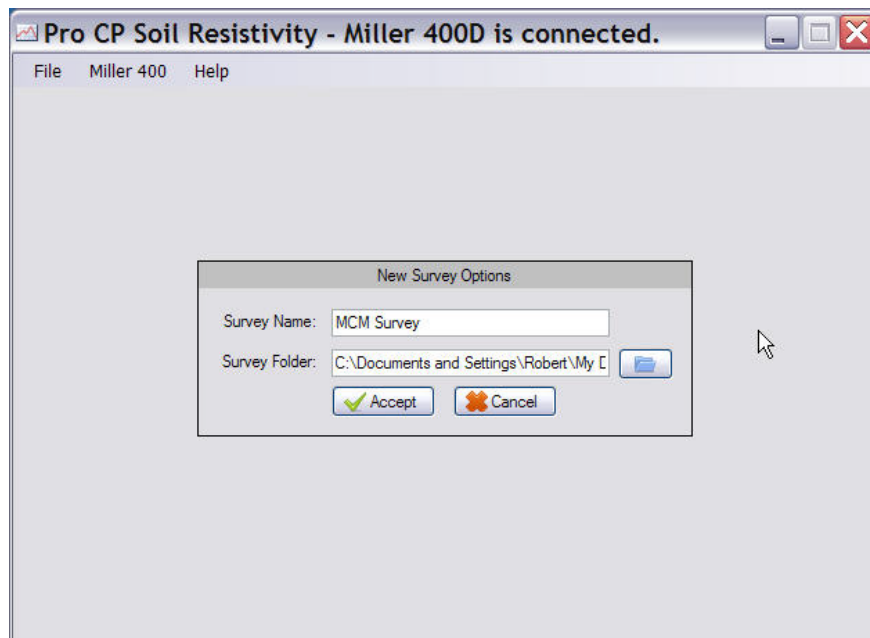

After selecting “Accept”, the window shown below (the Options Screen) will be displayed.

Re-opening a pre-existing survey file:

A pre-existing (saved) survey file can be re-opened, perhaps to continue adding data to the file. To do so, click or tap on the “Open Survey File” button and highlight the name of the survey file to be opened and click or tap on the “Open” button on the “Open ProCP Soil Resistivity Survey” window.

At this point, the window shown below (the Survey Screen) will be displayed.

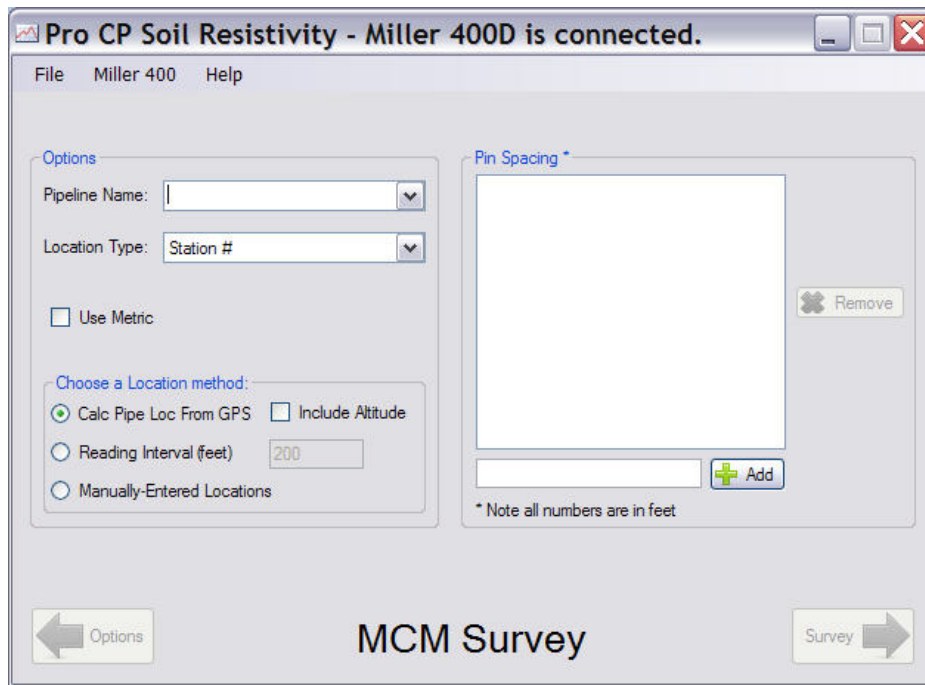

Options Field:

Pipeline Name: Enter a name for the pipeline over which the survey is being conducted (if known).

Location Type: By clicking or tapping on the drop-down menu button in the Location Type field, a selection can be made regarding how locations are displayed (Station #, Milepost or Miles plus Feet, or, their metric equivalents)

Use Metric: Make this selection for metric distance units rather than U.S. distance units. With this box checked, all distances will be in metric units.

Select one of the following options regarding stationing (measurement location information along the pipeline):

Calc Pipe Loc from GPS: With this option, the distance between the previous measurement



location and the current measurement location is calculated by the software and a station number is presented for the current position, based on the station number of the previous measurement location. The starting station number (if known) is entered on the survey screen prior to logging the first reading (see below).

Note: A straight line will be assumed between any two GPS locations for the purposes of the calculations. Also, if the “include altitude” option is not selected, it will be assumed that there is no altitude change between the two locations involved in a distance calculation. And, if the “include altitude” option is selected, the accuracy of the altitude data will significantly impact the accuracy of a calculated distance between two locations.

Reading Interval (feet or meters): With this option, the entered “Reading Interval” distance is added to the stationing each time a reading is logged, for the case of Downstream surveys, and, the entered “Reading Interval” distance is subtracted from the stationing each time a reading is logged, for the case of Upstream surveys. This is an ideal selection if survey flags, for example, have been laid out ahead of the soil resistivity survey, based on measured distances, and soil resistance readings are to be taken at each flagged location, say, every 200 feet, for example. The starting station number (if known) is entered on the survey screen prior to logging the first reading (see below).

Manually-Entered Locations: With this option, the user enters a station number at each measurement location prior to logging each reading. The starting station number is entered on the survey screen prior to logging the first reading (see below).

Pin Spacing Field:

Any number of “Pin Spacing” values can be entered which means that any number of soil resistance readings can be taken at each measurement location for soil resistivity versus depth profiling purposes.

Enter a value for the first pin spacing, in feet or meters, in the field opposite the “Add” button and click or tap on the “Add” button. This will place the pin spacing value into the Pin Spacing field. Repeat this process for each of your pin spacing values.

The window shown below indicates how the pin spacing values appear for the example case of 3 entered values, 20 feet, 10 feet and 5 feet. Note: Pin spacing values should be entered in the order in which the resistance readings are planned to be taken, since the reading prompts will appear automatically in the same listed order (see the Survey Screen section below).



Note: Highlighted pin spacings can be removed from the Pin Spacing field using the “Remove” button.

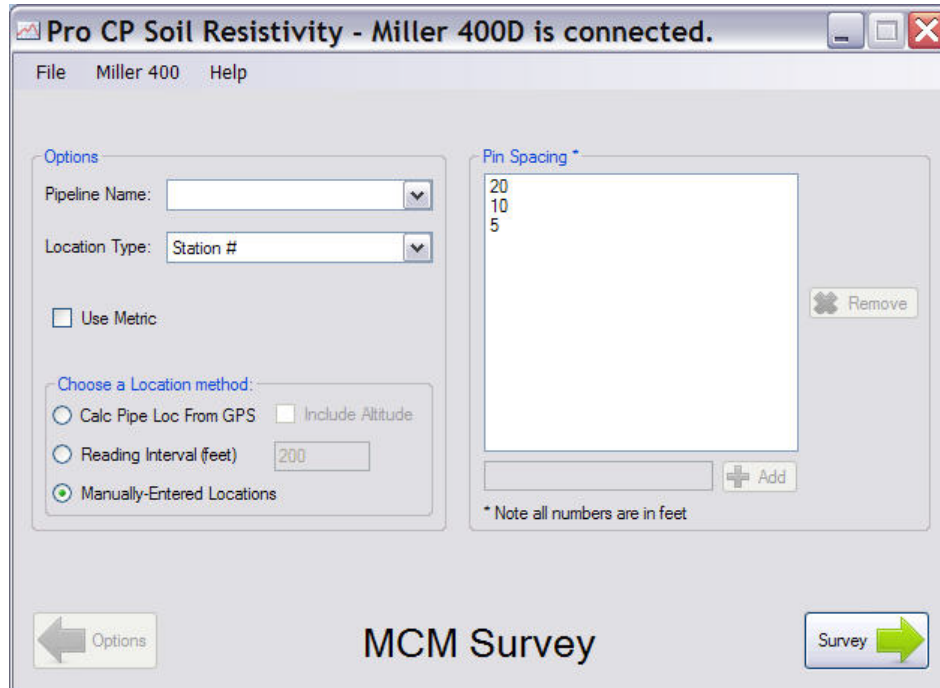

Survey Screen

After making “Options” and “Pin Spacing” selections, click or tap on the “Survey” button (lower right-hand corner), which will pull up the survey screen. An example survey screen is shown below for the case of 3 pin spacing values having been entered (20 feet, 10 feet and 5 feet).



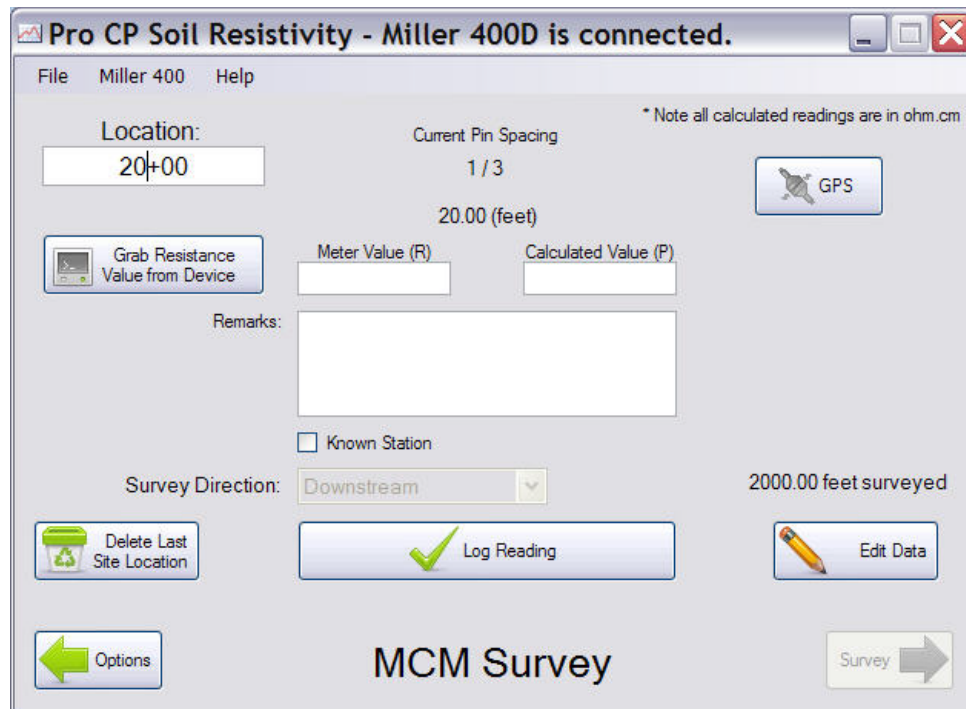

As indicated in the above window, the software is ready to acquire the meter value (resistance value) associated with the first-of-three pin spacing's (20 foot pin spacing in this example case).

A selection should be made for the “**Survey Direction**”, either Downstream or Upstream. This selection is important with regard to the first two “Location Method” options, namely, the “Calc Pipe Loc from GPS” and “Reading Interval” options. Downstream implies that the stationing will be increasing with each logged reading and Upstream implies that the stationing will be decreasing with each logged reading. Note: For the Upstream selection, it is important to enter a start station number that is sufficiently large so that the last data collection location on the survey still corresponds to a positive station number.

For the case of the “Manually-Entered Locations” option, it is not necessary to select the Survey Direction as only actual station numbers will be entered for each measurement location. For this case, the box labeled, “Known Station” will be automatically checked, as indicated on the above window, since all locations will have known station numbers.

The **start station number** should be entered (if known) and a reading acquired by clicking on the “**Grab Resistance Value from Device**” button on the survey screen. Alternatively, the “Read” button on the Miller 400D meter can be depressed after first placing the cursor in the “Meter Value” field.



Note: The reading acquisition time is approximately 5 seconds in either case.

The acquired resistance reading will appear in the “Meter Value (R)” field and the **calculated resistivity value**, based on the pin spacing, will appear in the “Calculated Value (ρ)” field. All calculated resistivity values are in ohm.cm units

Enter any textual remarks in the “**Remarks**” field

A resistivity value is saved by clicking or tapping on the “**Log Reading**” button.

Multiple Pin Spacing Readings:

In the case of multiple-pin spacing readings, each calculated resistivity value, based on each successively-acquired resistance value, is manually-logged in turn.

The window below shows the acquired resistance value (5.0Ω) and the calculated resistivity value ($19,248.1\Omega\cdot\text{cm}$) for the 20 foot pin spacing example (the first of 3 pin spacing readings).

Pro CP Soil Resistivity - Miller 400D is connected.

File Miller 400 Help

Location: 20+00

Current Pin Spacing 1 / 3

20.00 (feet)

* Note all calculated readings are in ohm.cm

Grab Resistance Value from Device

Meter Value (R) 5.0

Calculated Value (P) 19248.1

Remarks:

Known Station

Survey Direction: Downstream

1000.00 feet surveyed

Delete Last Site Location

Log Reading

Edit Data

Options

MCM Survey

Survey

The calculated resistivity value ($19,248.1\Omega\cdot\text{cm}$ in this example case), is saved by clicking or tapping on the “Log Reading” button. At that point, the second prompt screen automatically-appears, as shown below, and the resistance value acquired by clicking or tapping on the “Grab Resistance



Value from Device” button [or depressing the “Read” button on the Miller 400D] will be displayed in the “Meter Value” field.

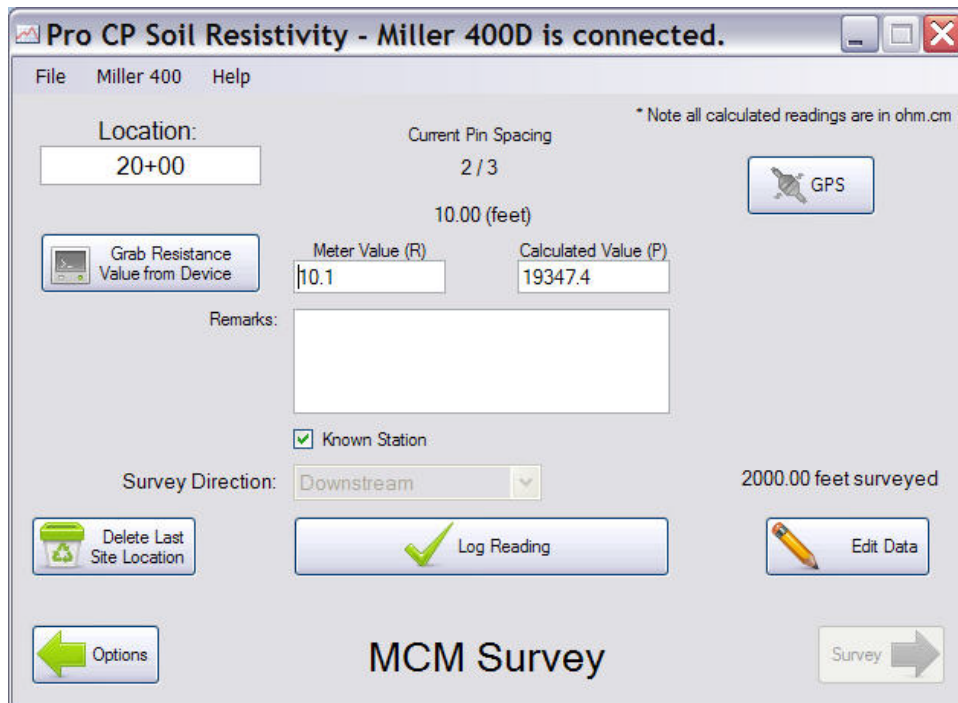

As indicated above, the acquired resistance value in this example, for the 10 foot pin spacing, is 10.1Ω and the calculated resistivity value is $19,347.4\Omega\cdot\text{cm}$.

The calculated resistivity value ($19,347.4\Omega\cdot\text{cm}$ in this example case), is saved by clicking or tapping on the “Log Reading” button. At that point, the third prompt screen automatically-appears, as shown below, and the resistance value acquired by clicking or tapping on the “Grab Resistance Value from Device” button [or depressing the “Read” button on the Miller 400D] will be displayed in the “Meter Value” field.

Pro CP Soil Resistivity - Miller 400D is connected.

File Miller 400 Help

Location: 20+00

Current Pin Spacing: 3 / 3

5.00 (feet)

* Note all calculated readings are in ohm.cm

Grab Resistance Value from Device

Meter Value (R): 15.1

Calculated Value (P): 14487.6

Remarks:

Known Station

Survey Direction: Downstream

2000.00 feet surveyed

Delete Last Site Location

Log Reading

Edit Data

Options

MCM Survey

Survey

The window above shows the acquired resistance value (15.1 Ω) and the calculated resistivity value (14,487.6 Ω .cm) for the 5 foot pin spacing example (the third of 3 pin spacing readings).

Clicking or tapping on the “Log Reading” button will save the final calculated resistivity value for this location (site) and a fresh prompt screen will be presented for the next location (next site).

The “**Delete Last Site Location**” button can be used to remove the resistivity value(s) saved at the last site, if readings need to be re-taken, for example. Note: If readings are to be re-taken at the “deleted” site, check the currently-displayed station number and manually-enter the station number of the current site (do-over) site location, if the currently-displayed station number is not appropriate.

Saved resistivity values can be viewed via the “**Edit Data**” button, and values can be edited also, if necessary.

Exporting Survey Data to Excel:

The soil resistivity data logged on a survey can be exported to Excel for future processing using the following procedure. Note: The export process can be performed while connected to, or disconnected from, the Miller 400D unit.



As indicated in the window below, an “**Export to Excel**” option is available via the File menu.

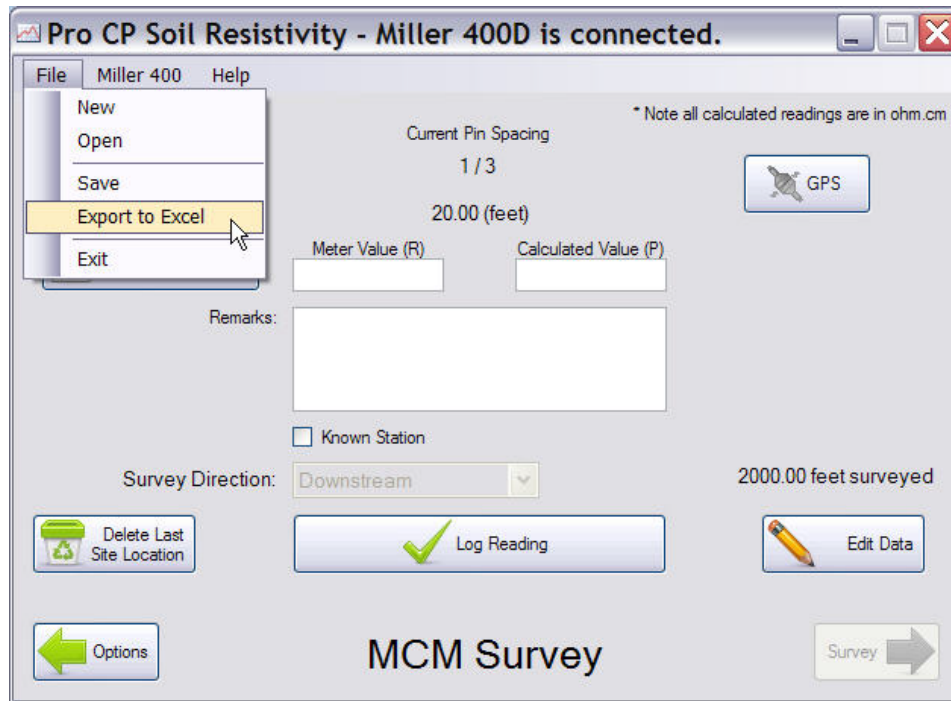

IMPORTANT FINAL STEP

It is important, at the completion of a survey, to disconnect the software application from the Miller 400D unit while the PDA or PC is in range of the unit.

Note: Disconnecting the WPAN connection will allow the WPAN radio in the Miller 400D to switch OFF (power-saving mode) after the LCD shuts down.

WARNING: If the software disconnection process is not carried out (within range of the Miller 400D), the WPAN radio will remain ON, even when the LCD automatically shuts down.

Select the “**Disconnect**” option from the “Miller 400D” menu, while in range of the Miller 400D.

Appendix 3: Influence of Test Lead Proximity (leads separate or bound together) on the Accuracy of Resistance Readings as measured by an AC Resistance Meter

Resistance Meter: Miller 400D (4-Terminal Digital Resistance Meter)

Experimental Test Leads: Four 12 feet long cables (# 16 AWG insulated wire)

Test Lead Configurations: Case 1 – test leads physically separate
Case 2 – test leads bound together via ties

Resistance reading with test leads separated from each other	Resistance reading with test leads bound together	Test lead proximity-related measurement error
7.3M Ω	6.4M Ω	12.3%
4.7M Ω	4.4M Ω	6.4%
1.0M Ω	996K Ω	0.4%
502K Ω	501K Ω	0.2%
50.1K Ω	50.1K Ω	zero
5.06K Ω	5.06K Ω	zero
5.11 Ω	5.11 Ω	zero

For load resistances greater than 1M Ω , in addition to internal meter errors, errors associated with test lead proximity can also be significant, as indicated above. When test leads are in close (physical) contact with each other, mutual capacitance and mutual inductance effects can impact the current and voltage, respectively (and hence the resultant resistance value). In such cases, the load (appearing across the input terminals of the meter) is not purely resistive, but, has reactive components as well. In particular, an effective shunt capacitor (due to the test leads being in close proximity) will bleed-off some of the current (current that would have otherwise flowed through the resistive soil), leading to inaccurate resistance values. High resistance readings are particularly-affected by the shunt capacitance since the output currents are so small in such cases and the current leakage effect is therefore magnified.

The solution to this issue is to make sure that the test leads are physically separated from each other in cases where the soil resistance is greater than 1M Ω . So, for example, in the case of the M. C. Miller 4-test lead reel, the test leads should be physically-separated from each other (ties removed) if very high (>1M Ω) resistances are to be measured.

Note: This should only be an issue for soil with essentially zero moisture content since a 1M Ω soil resistance translates to a $1,000 \times 10^6 \Omega \cdot \text{cm}$ soil resistivity for a 5 feet pin spacing, for example.



Appendix 4: Specifications:

Storage temperature range (with batteries installed):	-40°C to 50°C (-40°F to 122°F)
Operating temperature range:	-20°C to 54°C (-4°F to 129°F)
Weight:	8.6 lbs (3.9kg)
Width:	12in (30.5cm)
Length:	10.5in (26.7cm)
Height:	5.75in (14.6cm)
<u>Accuracy:</u>	
0.01Ω to 1MΩ range	±1.6% ±1LS Display Digit ±0.01Ω
1MΩ to 10MΩ range*	±5% ±1LS Display Digit

Note: The “High Resolution LCD Display Mode should only be used for resistance values less than 1 ohm

Appendix 5: Connecting Configuration Program and Pro CP Soil Resistivity Program via PC-based WPAN adapter.

A WPAN adapter, integrated or USB type, can be used to connect the Miller 400D to your PC. Refer to the below WPAN settings for this type of adapter.

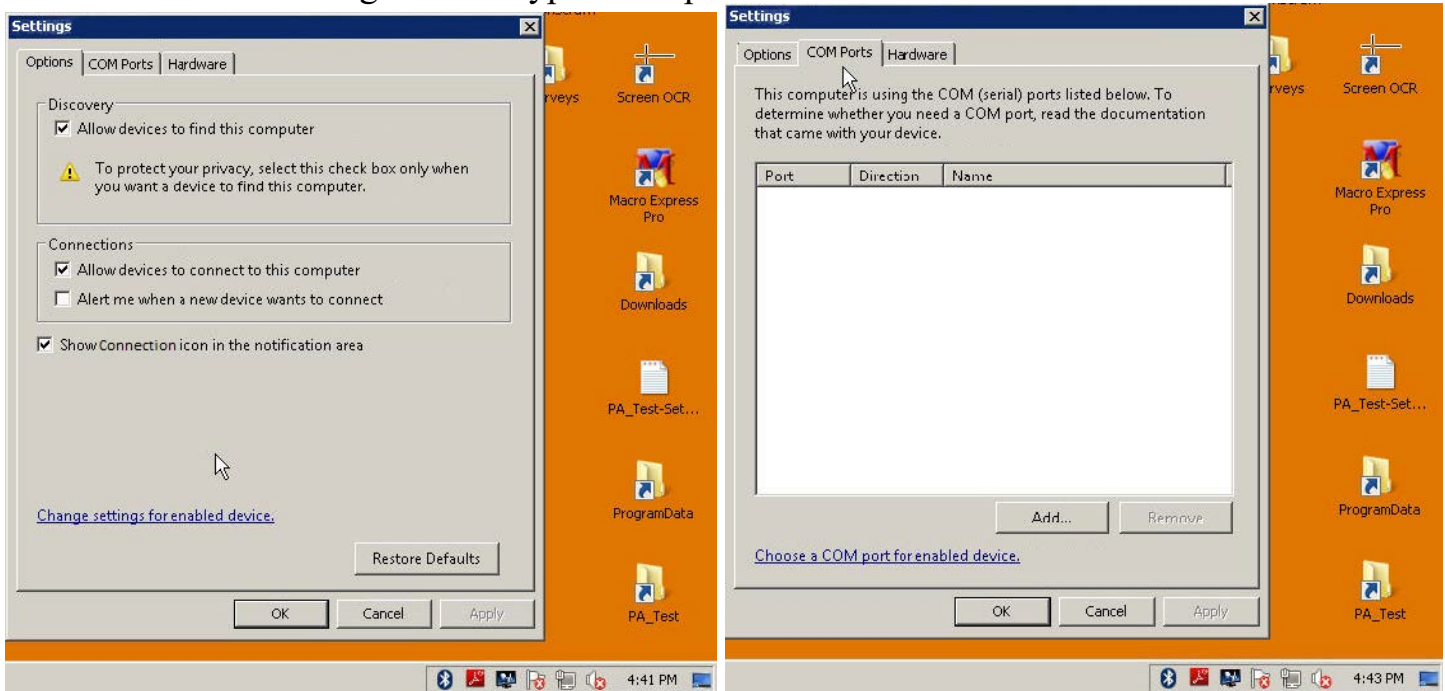

A WPAN connection is initiated by the *Configuration Program* via the following procedure:

With the PC within range (within 30 feet) of the “...400D”, left-mouse click on the “**Miller 400D**” menu and click on the “**Connect→Search**” option, as indicated below, left side. This will initiate the search for WPAN devices. When a device is found, the message on the below, right side will appear.

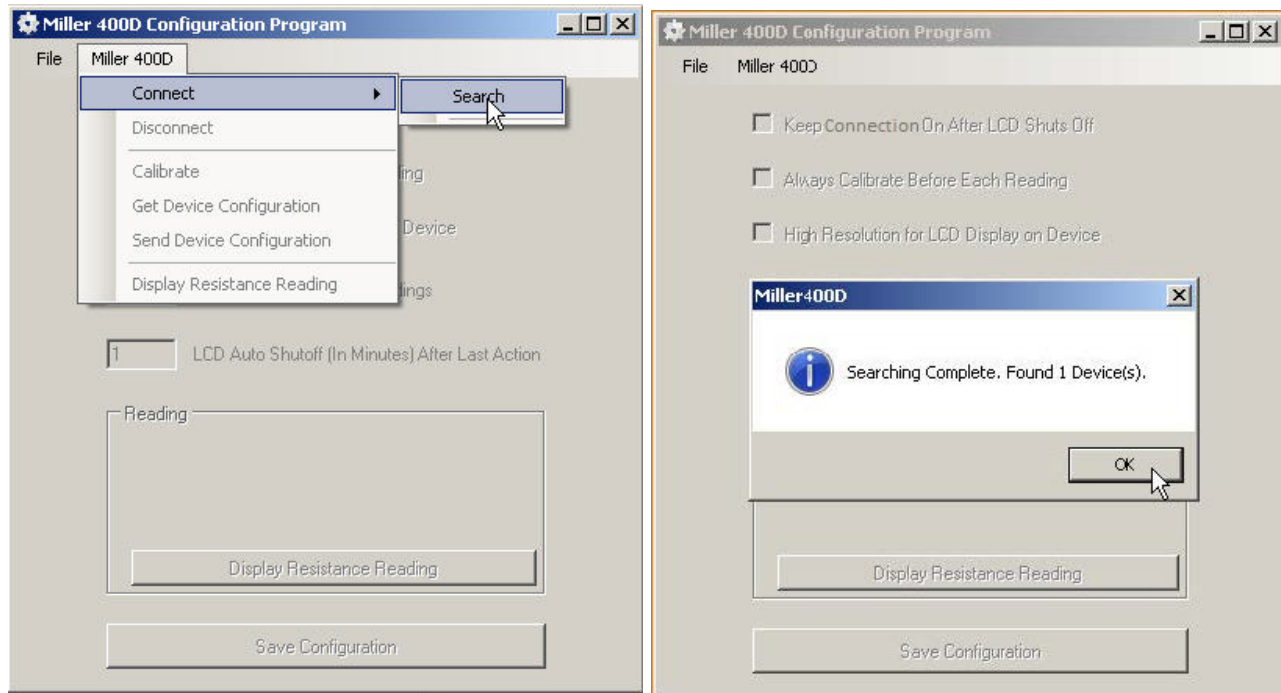

Click the “**OK**” button. At this point a WPAN device has been found, we still have to connect to the device, presumably the “...400D” device was found.

At this point left-mouse click on the “**Miller 400D**” menu and click on the “**Connect→MCM_Miller400D**” device, as indicated below left side. A following message, below right side will be displayed to make sure the “**...400D**” is powered-on. Depress the “**Read**” button on the “**...400D**”, which turns the unit ON and then click the “**Yes**” button in response to the message.

Note: A few seconds are required to establish a connection. Also, the above process may have to be repeated more than once for a WPAN connection to be established.

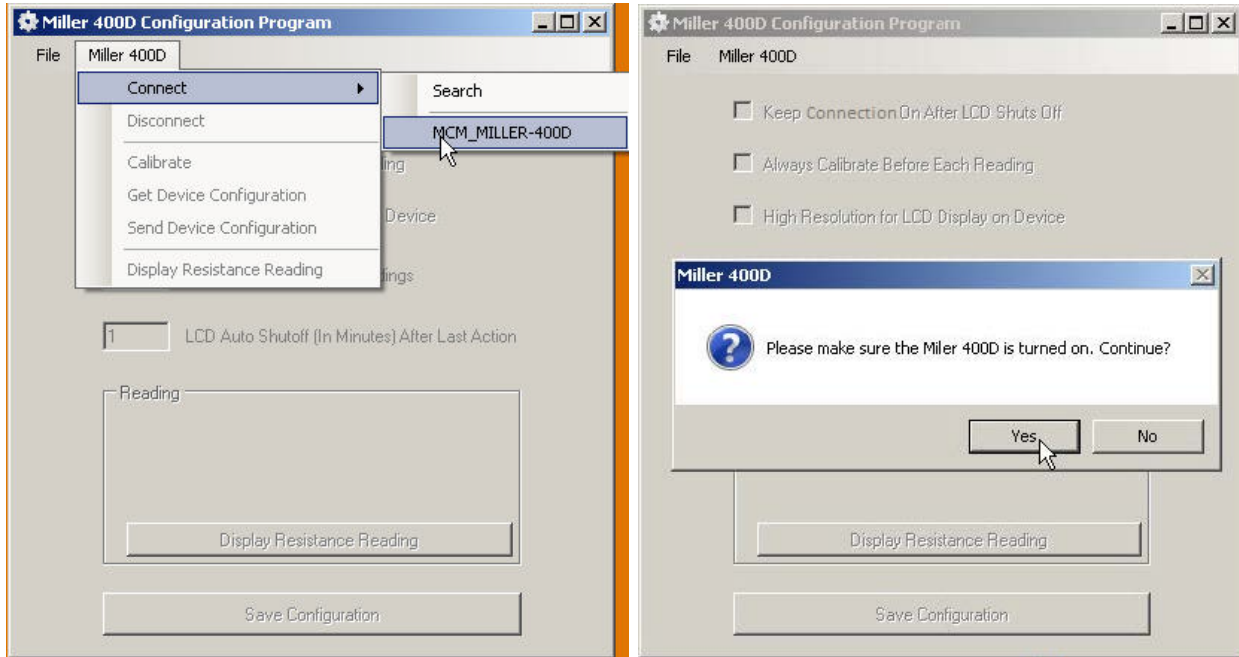

When a connection is established, the window shown below will be displayed:

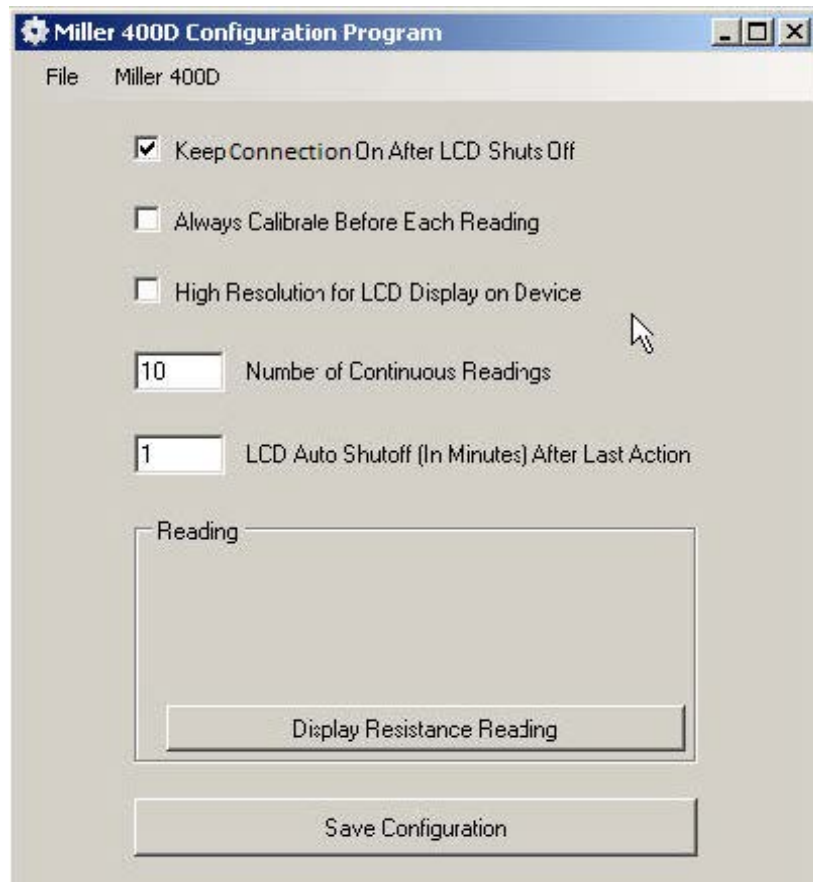

Note that the window above has all the fields and buttons enabled. You can now perform changes to the (power-saving) default settings or a reading can be initiated, and the meter reading can be displayed on the above window either by clicking or tapping on the “**Display Resistance Reading**” button, or, by depressing the “**Read**” button on the Miller 400D. The reading acquisition time may take 3-5 seconds. Other considerations:

- If the WPAN is set to remain on after LCD shuts down, battery life will be reduced during long term storage. De-select this prior to storage.
- It is suggested that the LCD Auto shut off be set to 5 minutes for most applications. This setting can be changed to suit your needs.
- High resolution mode on LCD Display should only be used for resistance values under 1Ω.

A WPAN connection is initiated by the “*Pro CP Soil Resistivity*” program in a similar manner as shown previously for the “**Configuration Program**”. However, note that the “**Pro CP...**” window title will show whether the “**...400D**” is “**connected**” or “**not connected**”. The following procedure describes this connection process:

With the PC within range (within 30 feet) of the “**...400D**”, left mouse click on the “**Miller 400D**” menu and click on the “**Connect→Search**” option, as indicated below, left side. This will initiate the search for WPAN-enabled devices.

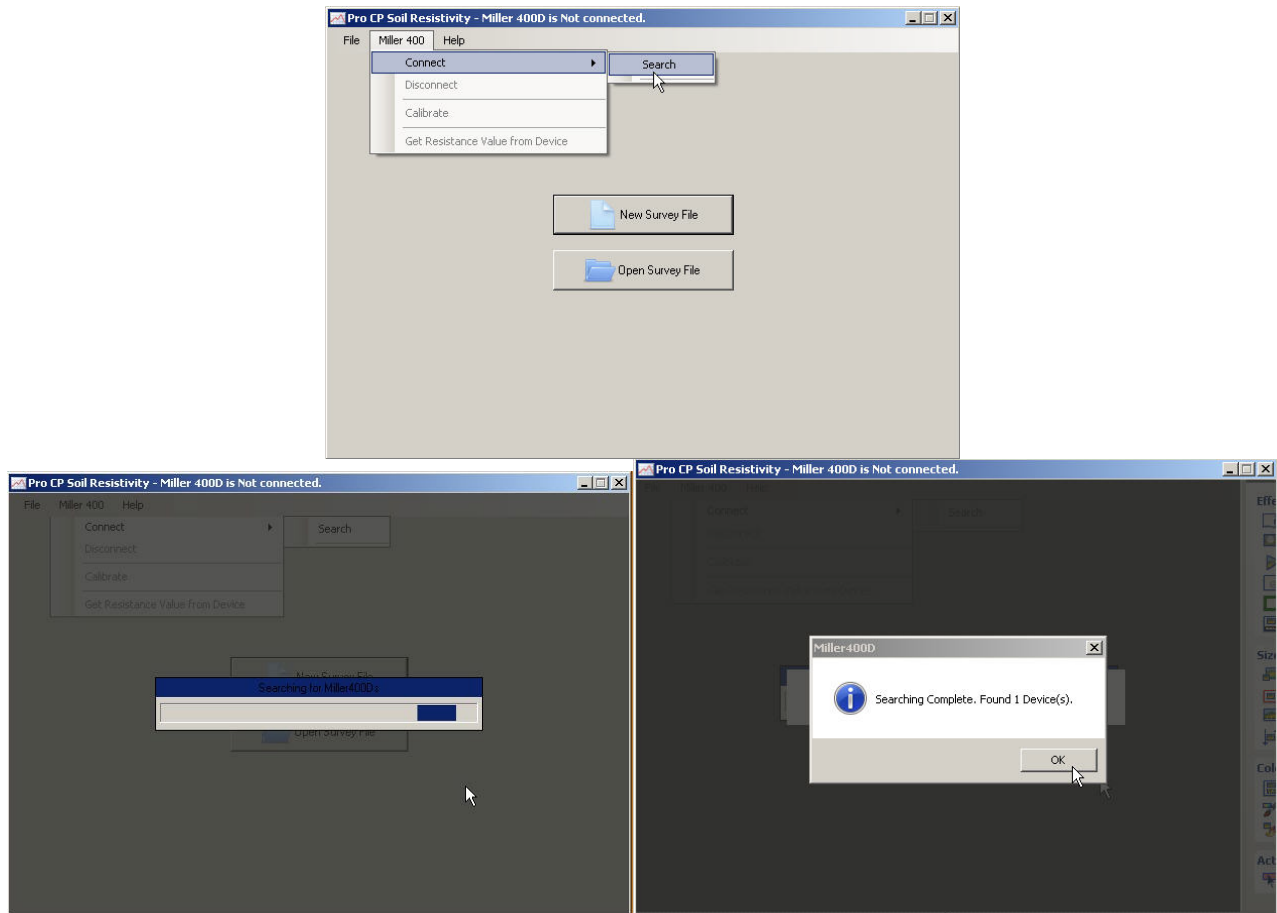

During the search, a “**progress window**” may appear, above left side. When a device is found, the message on the above, right side will appear. Click the “**OK**” button. At this point a WPAN device has been found, we still have to connect to the device, presumably the “**...400D**” device was found.

At this point left-mouse click on the “**Miller 400D**” menu and click on the “**Connect→MCM_Miller400D**” device, as indicated below left side. A following message, below right side will be displayed to make sure the “**...400D**” is powered-on. Depress the “**Read**” button on the “**...400D**”, which turns the unit ON and then click the “**Yes**” button in response to the message.

Note: A few seconds are required to establish a connection. Also, the above process may have to be repeated more than once for a WPAN connection to be established.

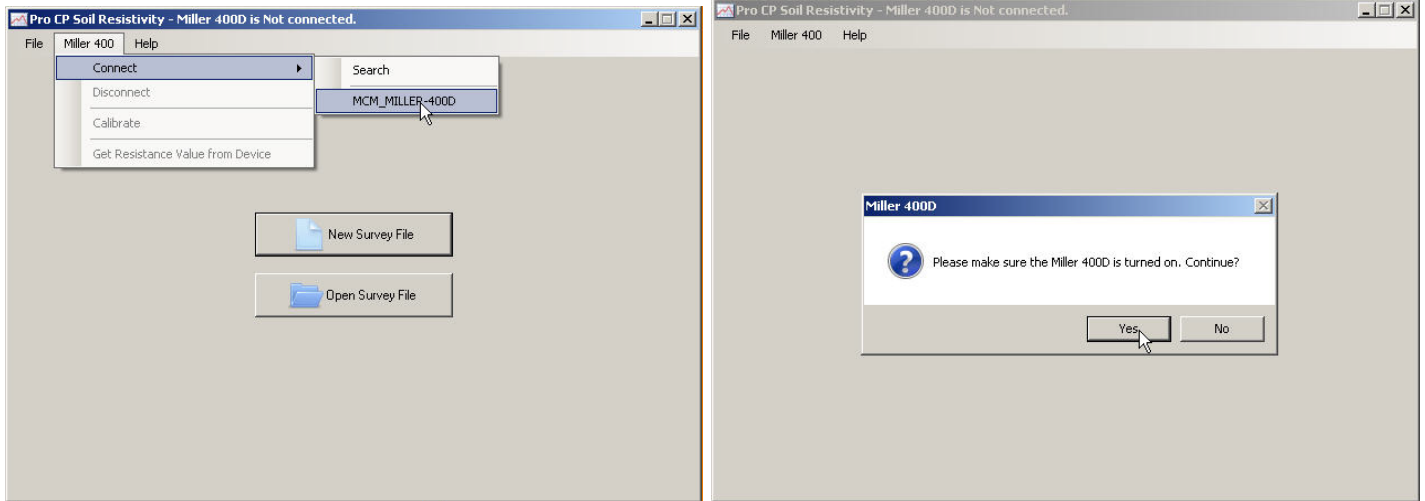

When a connection is established, the window shown below will be displayed. Note that the window title shows that the “...400D” is now “**connected**”.

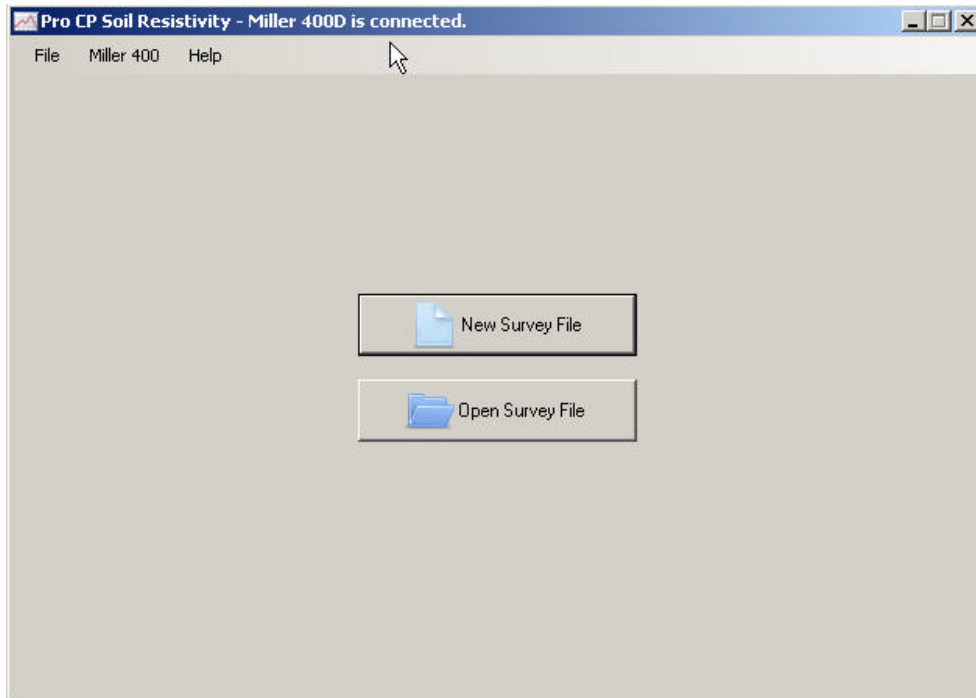

You can now create a “**New**” survey or continue an existing survey by clicking the “**Open Survey File**” button.